

Since 1968

COMMAX
SmartHome & Security

User Manual

Door Camera DRC-4CPN2



www.commax.com

COMMAX Co.,Ltd.



- Thank you for purchasing COMMAX products.
- Please carefully read this User's Guide (in particular, precautions for safety) before using a product and follow instructions to use a product exactly.
- The company is not responsible for any safety accidents caused by abnormal operation of the product.



Contents

1. Introduction.....	2
2. Important Safeguard.....	3
3. The names & Functions of Each Part.....	4
4. Wiring & Installation.....	6
5. Package.....	11
6. Specifications.....	13



1. Introduction

Your unit is designed so it can be flush mounted on the or used. When flush mounted on the wall, the stand permits you to the unit for an gular of unit view. The model number is located on the bottom and record the serial number in the space provided below(available). Refer to these numbers whenever you call upon your COMMAX dealer regarding this product.

Model No.

Serial No.

To prevent fire or shock hazard, do not expose the unit to rain or moisture.



This symbol is intended to alert the use to the presence of uninsulated **"dangerous Voltage"** within the product' s enclose that may be of sufficient magnitude to constitute a risk of electric shock to persons.



This symbol is intended to alert the use to the presence of important operating and maintenance(servicing) instructions in the literature accompanying the appliance



caution

Rosk of electric shock
do not open



CAUTION: To reduce the risk of electrix shick, do not remove cover(or back) no user-serviceable part sinside refer servicing to quared service personnel



2. Important Safeguards

- ▲ **Damage Requiring Service:** This equipment from the power source and source and refer servicing to qualified service personnel under the following conditions:
 - Ⓐ when the power is damaged.
 - Ⓑ if liquid has been spilled or objects have fallen into the unit
 - Ⓒ if the equipment has been exposed to rain or water.
 - Ⓓ if the equipment has been dropped or otherwise damaged.
 - Ⓔ when the equipment exhibits a distinct change in performance- this indicates a need for service.
- ▲ **Water and Moisture:** Do not use this product near water, for example, near a bath tub, wash bowl, kitchen sink, or laundry tub, in a wet basement, or near a swimming pool, and the like.
- ▲ **Accessories:** The product may fall, causing serious injury to a child or adult, and serious damage to the appliance. Any mounting of the manufacturer's instructions, and should use a mounting accessory recommended by the manufacturer.
- ▲ **Object and Liquid Entry:** Never push objects of any kind into this product through openings as they may touch dangerous voltage points or short-out parts that could result in a fire or electric shock. Never spill liquid of any kind on the product.
- ▲ **Lightning:** For added protection for this product before a lightning storm, or when it is left unattached and unused for long periods of time, unplug it from the wall outlet and disconnect the other system. This will prevent damage to the product due to lightning and power-line surges. If you live in an area heavily prone to lightning storms, it is recommended that you invest in power-line, telephone-line, RF cable and actuator/ polarization surge protectors to protect your appliance system from possible damage



3. The names & Functions of Each Part

► Front sid

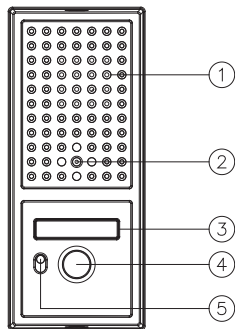

► Back side

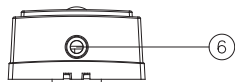
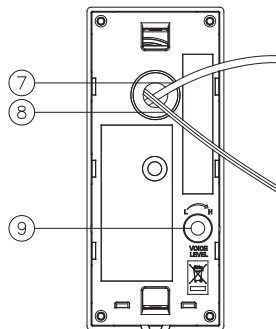

①	Speaker : Transmit sounds from the household.
②	Camera Lens : keep cleaning up from dust or foreign substances.
③	LED Lamp : The LED lamp is turned on for clear view during night.
④	Page Button : Used to page the household
⑤	Microphone : For use when communicating with the household
⑥	Mounting Holes
⑦	Monitor cable : Connect with household monitor after matching up the polarity
⑧	Door release cable : Connect with door release switch
⑨	Volume control : Used to adjust speaker volume



4. Wiring & Installation

1. Align holes on the wall where the unit is to be installed with mounting brackets hole and secure.

FIG-1 : Install the camera at a 30 ° angle to the left

(install the bracket in reverse to angle 30 ° to the right)

FIG-2 : Install the camera at a perpendicular angle to the front

2. Wire the household monitor cables as shown below with matched polarity as picture below[FIG-3]

(#1:RED/VOICE, #2:BLUE/GND, #3:YELLOW/DC12V, #4:BLACK/VIDEO)

3. Wire the door release cable as shown in the diagram.[FIG-3]
4. Tighten using bolts and a wrench, then cover using the AL. screw covers.

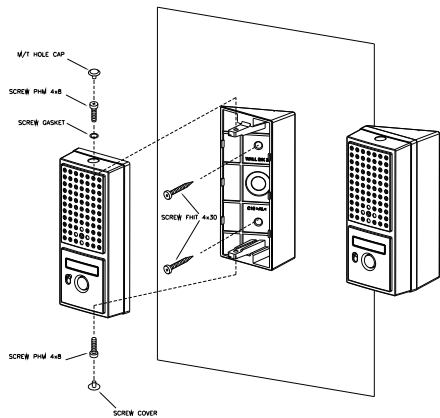

▶ [FIG-1]

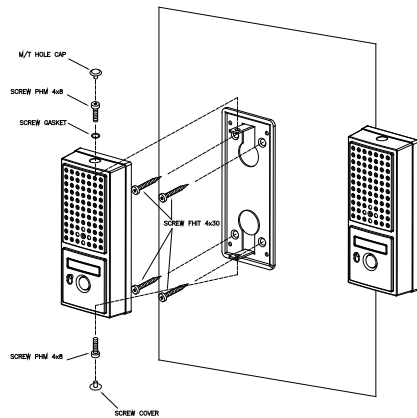

▶ [FIG-2]

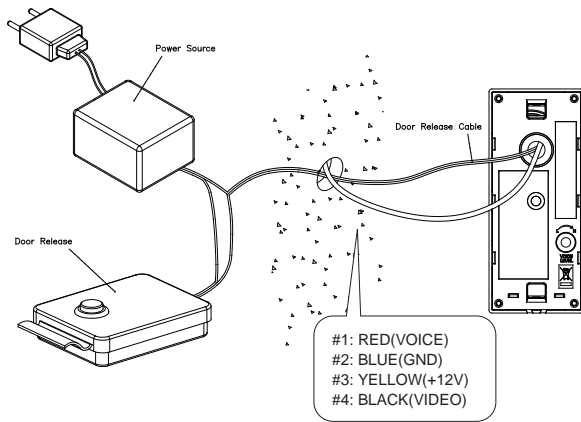

▶ [FIG-3]

* You can adjust speaker volume using driver as shown below. [FIG-4]

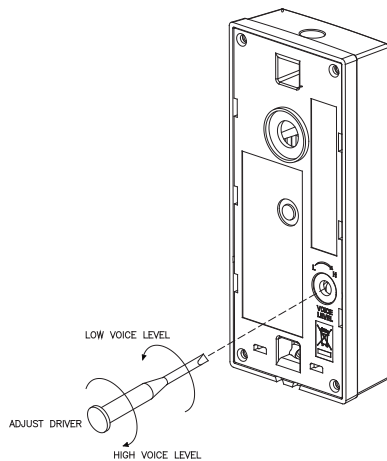

▶ [FIG-4]

- Please refer to the below images regarding the installation position of the product.

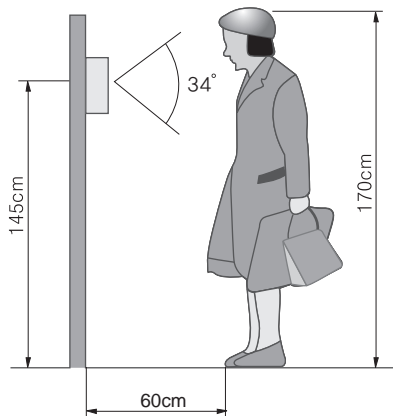

5. Package

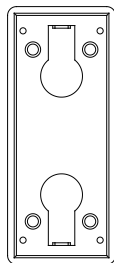
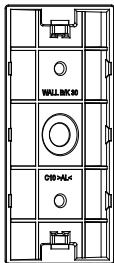
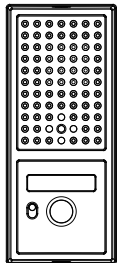
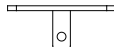
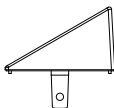



M/T HOLE CAP



GASKET



SCREW PHM 4*8

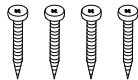

SCREW FH1T 4*30



SHEET VOLUME

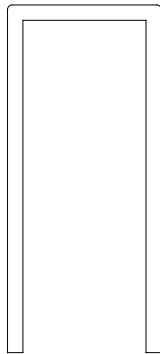

RUBBER WATERPROOF



6. Specification

specification	Model
	DRC-4CPN2
Image Sensor	CMOS 1/4"
Power source	12V $\overline{=}$ (supplied from the Monitor)
Wiring(household)	Polar 4 wires
Call mode	Duplex
Camera angle	horizontal angle 47°, vertical angle 34°
Format	NTSC or PAL STANDARD
Horizontal /vertical Frequency	15.734 ^{KHz} / 60 Hz , 15.625 ^{KHz} / 50 Hz
Lamp	Built-in white LED (automatically turns on in night)
Low illumination	0.1 LUX (Up to 300mm in front of the camera)
Workable temperature	-10℃ (tested up to -40℃) +50℃
Dimension(mm)	50(W) x 118 (H) x 25.5(D)
Weight(g)	250g (B/K included)

COMMAX

COMMAX Co.,Ltd.

513-11, Sangdaewon-dong, Jungwon-gu, Seongnam-si, Gyeonggi-do, Korea
Int'l Business Dept. : Tel.; +82-31-7393-540~550 Fax.; +82-31-745-2133
Web site : www.commax.com

PM104CPN2000

Printed In Korea / 2013.10.105